

Decorative Capitals For Round Columns

Marble Fiberglass Reinforced Polymer Composite Product Manufactured By Timeless Architectural Reproductions, Inc.™

6" Roman Ionic

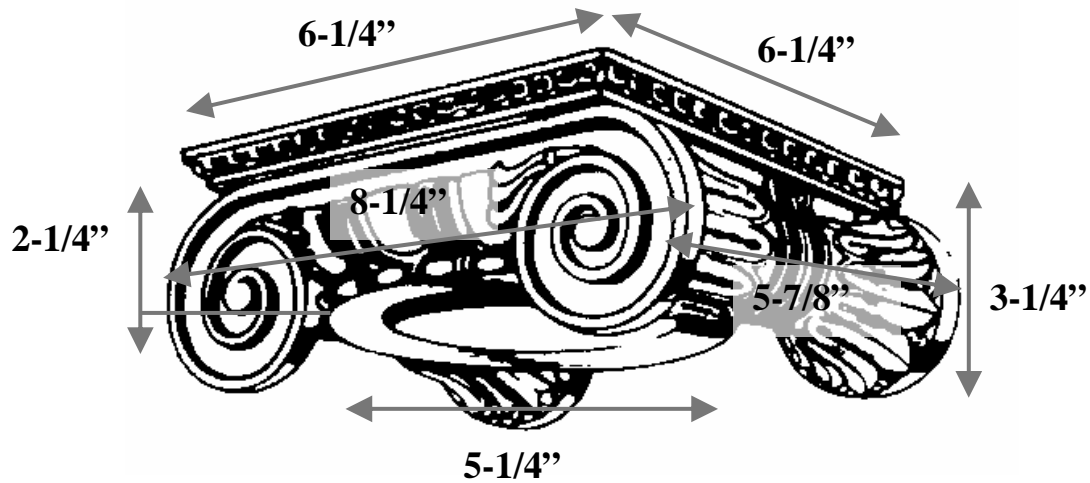

Item #	I06-56
Material	Resin and marble composite
Load Bearing	Yes
Product Weight	6 lbs
Shipping Weight	8 lbs
Base	5-1/4"
Inside Ring	2-1/8" (ring not shown)
Outside Ring	5-1/2"
Capital Height	2-1/4"
Abacus	6-1/4" x 6-1/4"
Scroll to Scroll	8-1/4" x 5-7/8"
Scroll Height	3-1/4"



TIMELESS ARCHITECTURAL REPRODUCTIONS, INC.™

Designers & Manufacturers of Classic Architectural Products

2655 Northgate Avenue
Cumming, GA 30041
(770) 205-1446 • (800) 665-4341 Office
(770) 205-1447 Fax
www.TimelessArchitectural.com

