

Decorative Capitals For Round Columns

Marble Fiberglass Reinforced Polymer Composite Product Manufactured By Timeless Architectural Reproductions, Inc.™

14" Roman Ionic

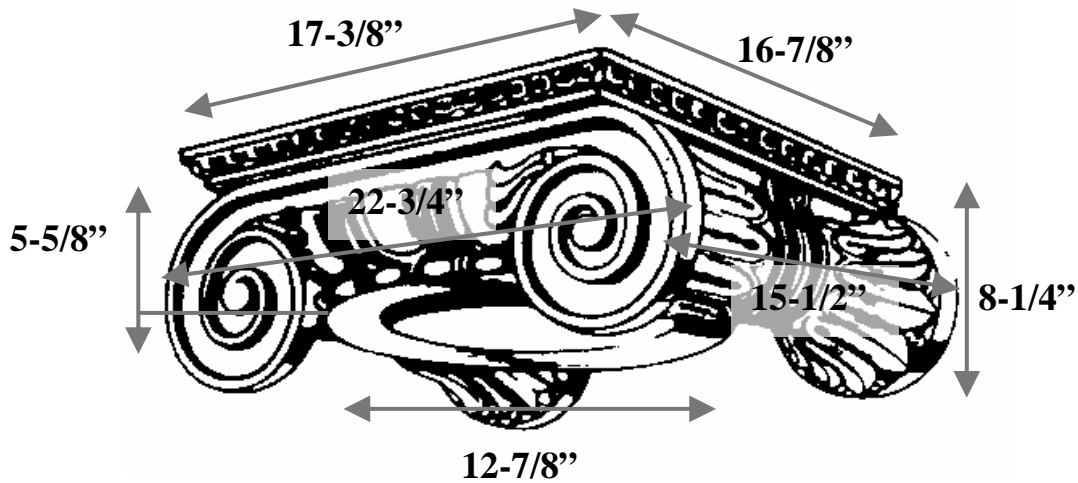

Item #	I14-20
Material	Resin and marble composite
Load Bearing	Yes
Product Weight	70 lbs
Shipping Weight	77 lbs
Base	12-7/8"
Inside Ring	8-1/2" (ring not shown)
Outside Ring	10-1/4"
Capital Height	5-5/8"
Abacus	17-3/8" x 16-7/8"
Scroll to Scroll	22-3/4" x 15-1/2"
Scroll Height	8-1/4"



TIMELESS ARCHITECTURAL REPRODUCTIONS, INC.™

Designers & Manufacturers of Classic Architectural Products

2655 Northgate Avenue
Cumming, GA 30041
(770) 205-1446 • (800) 665-4341 Office
(770) 205-1447 Fax
www.TimelessArchitectural.com

