

Decorative Capitals For Round Columns

Marble Fiberglass Reinforced Polymer Composite Product Manufactured By Timeless Architectural Reproductions, Inc.™

6" Temple of Wind

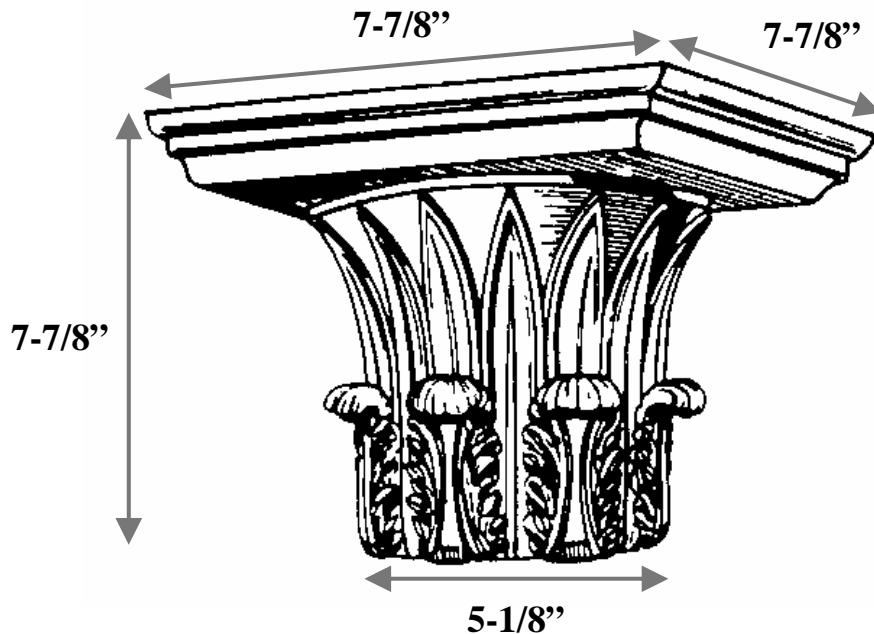

Item #	T06-66
Material	Resin and marble composite
Load Bearing	Yes
Capital Weight	6 lbs
Shipping Weight	8 lbs
Base	5-1/8"
Inside Ring	2-1/2" (ring not shown)
Outside Ring	3-1/4"
Height	7-7/8"
Abacus	7-7/8" x 7-7/8"



TIMELESS ARCHITECTURAL REPRODUCTIONS, INC.™

Designers & Manufacturers of Classic Architectural Products

2655 Northgate Avenue
Cumming, GA 30041
(770) 205-1446 • (800) 665-4341 Office
(770) 205-1447 Fax
www.TimelessArchitectural.com

