

Decorative Capitals For Round Columns

Marble Fiberglass Reinforced Polymer Composite Product Manufactured By Timeless Architectural Reproductions, Inc.™

10" Temple of Wind

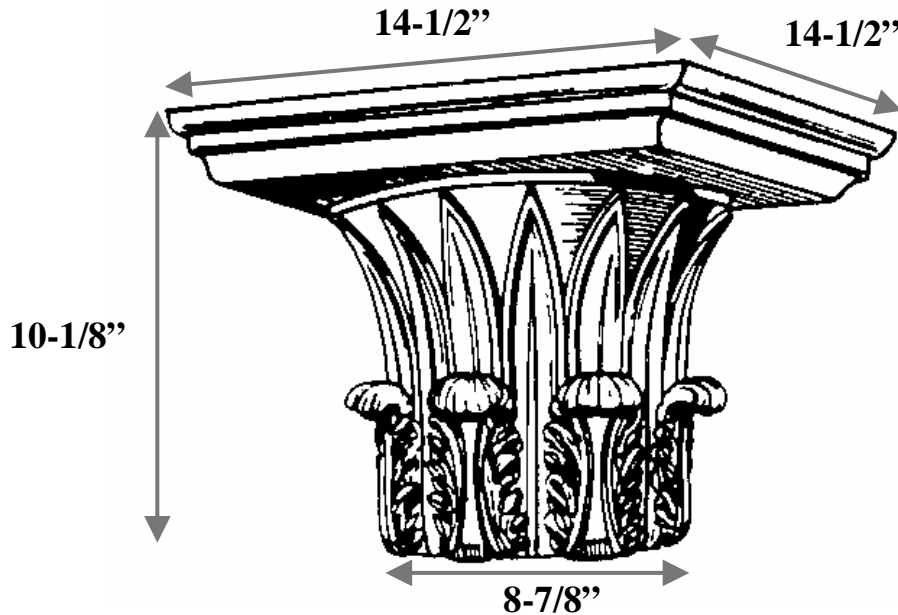

Item #	T10-49
Material	Resin and marble composite
Load Bearing	Yes
Capital Weight	29 lbs
Shipping Weight	36 lbs
Base	8-7/8"
Inside Ring	5-1/8" (ring not shown)
Outside Ring	6-1/4"
Height	10-1/8"
Abacus	14-1/2" x 14-1/2"



TIMELESS ARCHITECTURAL REPRODUCTIONS, INC.™

Designers & Manufacturers of Classic Architectural Products

2655 Northgate Avenue
Cumming, GA 30041
(770) 205-1446 • (800) 665-4341 Office
(770) 205-1447 Fax
www.TimelessArchitectural.com

