

# Decorative Capitals For Round Columns

Marble Fiberglass Reinforced Polymer Composite Product Manufactured By Timeless Architectural Reproductions, Inc.™

## 12" Temple of Wind

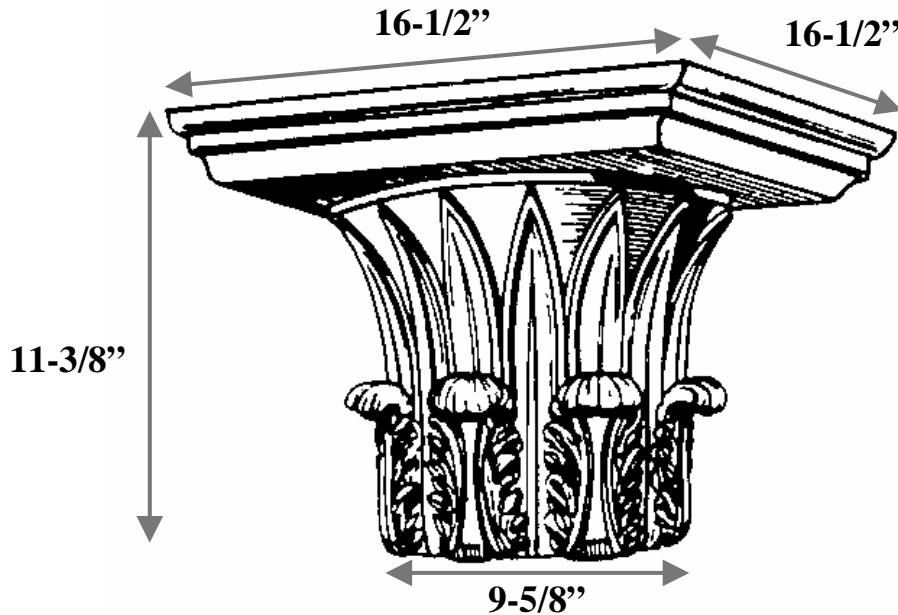

Item #	T12-54
Material	Resin and marble composite
Load Bearing	Yes
Capital Weight	41 lbs
Shipping Weight	55 lbs
Base	9-5/8"
Inside Ring	5-1/8" (ring not shown)
Outside Ring	7-1/8"
Height	11-3/8"
Abacus	16-1/2" x 16-1/2"



**TIMELESS ARCHITECTURAL REPRODUCTIONS, INC.™**

*Designers & Manufacturers of Classic Architectural Products*

2655 Northgate Avenue  
Cumming, GA 30041  
(770) 205-1446 • (800) 665-4341 Office  
(770) 205-1447 Fax  
[www.TimelessArchitectural.com](http://www.TimelessArchitectural.com)

